

General set up

- 1 Mount the fixture in the required position. The integral yoke can act as a floor stand or hanger.

Important

- When suspended off ground, always use a safety wire rated to a minimum of 34kg (75lbs) around the yoke.
- Do not position the fixture close to fog machines. The fog oil mist will be drawn in by the cooling fan and will short out important components. The warranty will be void for all fixtures returned in such a condition.

- 2 Where external control is to be used, connect a DMX lead (XLR 5-pin female) to the input socket at the rear of the fixture.

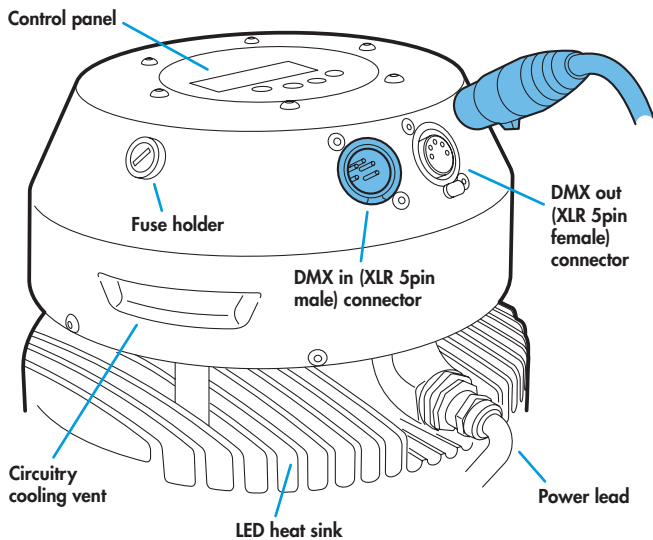

- 3 Where other fixtures are to be used in a control daisy-chain, connect a DMX lead (XLR 5-pin male) to the output socket at the rear of the fixture.
- 4 Connect power to the fixture.
- 5 Use the control panel to access the internal menu and choose the appropriate operation mode and related settings (see over).

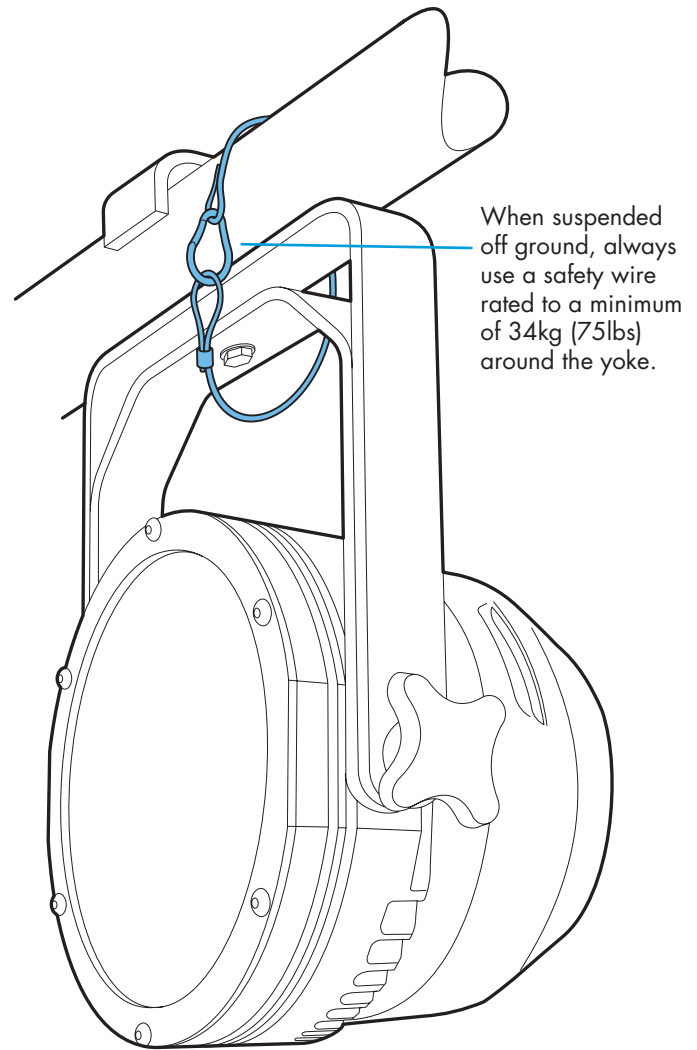
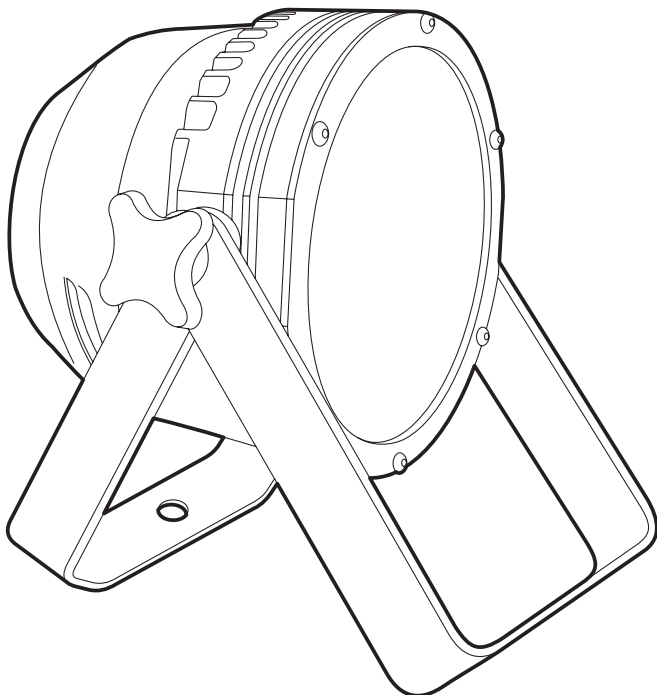



Operation modes

The PixelPar 90 provides a range of operation modes. These are selected using the **Mode** section of the control menu:

- DM** Allows RGB control via DMX input. Internal chase effects are not available within this mode.
- MA:1** Legacy mode that makes inefficient use of DMX channels. Use **MA:2** in preference.
- MA:2** Provides control of RGB mixing and selection of the dual internal chase effects via DMX input. Requires 10 DMX channels.
- MANU** Provides RGB colour mixing independently of any external control. Use the internal control menu (**MAN** section) to select the required colour values.
- EF M** Allows the display of the dual internal chase effects, independently of any external control. Use the internal control menu (**PRGB** section) to select the required chase effects, speeds and cross fades.
- EF d** Superseded by (and operates in a similar manner to) **MA:2**. RGB mixing and chase effects cannot be used at the same time. Requires 7 DMX channels.
- EXB 1** Legacy mode that makes inefficient use of DMX channels. Use **MA:2** in preference.





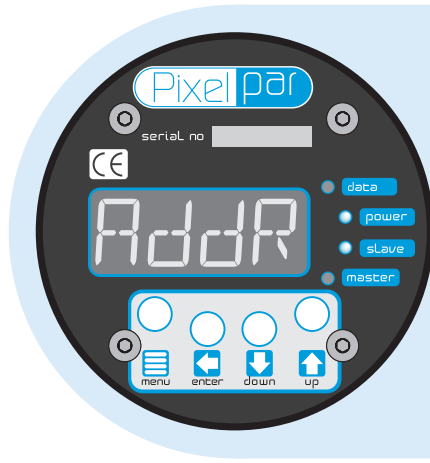

PixelPar 90 personalities are available for a variety of controllers. Please see www.pixelrange.com for details.

General notes

- Ensure that only one DMX device in the chain is set as master (e.g. the lighting desk). This fixture is usually set to slave mode .
- This fixture is shipped with the DMX address set to 001.
- If the fixture is used as a master, DMX transmission will only occur when the DMX address is displayed (e.g. 0001, 0002, etc).
- The four digit display can be set to fade out after 60 seconds, press  to resume. To alter this mode: `PERS > DISP`.



Using the control menu

- When not in the menu, the four digit display shows the current DMX address e.g. 0001
- Press  to enter the menu. The four digit display will show Addr.
- Use  and  to move between menu options (or to change a value within an option).
- Press  to enter an option (or to fix a changed value within an option and return to the previous option level). *Note: If you do not press  to fix a value, operation will revert to the previously set mode at the next power on.*
- Press  to exit from a menu option (and eventually exit the menu completely).

Chase effects

This section describes each of the 31 internal chase effects that are selectable either via the control menu (`PRPG > C 1/2 > EFEC`) or using DMX values sent from an external source. To use the internal effects, set the `MODE` option either to `EF 1` (to control effects via the menu) or `MA:2` (to control effects externally via DMX).

DMX value	EFEC value	Chase effect description
0-7	00	Off
8-15	01	Rainbow chase forward
16-23	02	Rainbow chase reverse
24-31	03	10/90 duty cycle strobe white
32-39	04	10/90 duty cycle strobe white
40-47	05	10/90 duty cycle strobe white
48-55	06	50/50 duty cycle strobe white
56-63	07	50/50 duty cycle strobe red
64-71	08	50/50 duty cycle strobe blue
72-79	09	50/50 duty cycle strobe yellow
80-87	10	50/50 duty cycle strobe green
88-95	11	Pulse strobe white
96-103	12	Pulse strobe blue
104-111	13	Pulse strobe rainbow
112-119	14	Pulse strobe red/green/blue
120-127	15	Primary/secondary chase
128-135	16	Rainbow chase
136-143	17	Yellow/blue chase
144-151	18	Rainbow chase
152-159	19	Yellow/blue chase
160-167	20	Red/blue chase
168-175	21	Red/green chase
176-183	22	Rainbow chase
184-191	23	Purple/white/green chase
192-199	24	Rainbow chase
200-207	25	Static orange
208-215	26	Static yellow
216-223	27	Static light blue
224-231	28	Static purple
232-239	29	Static red
240-247	30	Static green
248-255	31	Static blue

Chase effects and master intensity channel layouts

The table below shows how the chase effects and master intensity controls are mapped to DMX channels for each mode. Mode `dm:1` does not use chase effects. The first channel of the fixture occurs at the DMX address selected using `Addr` and successive channels for the fixture follow from there. `MA:1`, `EF d` and `E:6 1` are legacy modes which do not provide the best performance. You are recommended to use `MA:2` for combined RGB colour mixing and chase effect control.

Control	MA:1	MA:2	EF d	E:6 1
C 1 Effect	Ch55	Ch4	Ch1	Ch56
C 1 Speed	Ch56	Ch5	Ch2	Ch57
C 1 Xfade	Ch57	Ch6	Ch3	Ch58
C 2 Effect	Ch58	Ch7	Ch4	Ch59
C 2 Speed	Ch59	Ch8	Ch5	Ch60
C 2 Xfade	Ch60	Ch9	Ch6	Ch61
RGB master intensity	None	None	None	Ch55
Effects master intensity	None	None	None	Ch62
Combined master intensity	Ch61	Ch10	Ch7	None

Note

When using `dm:1` mode for colour mixing (no chase effects possible) and the `MINT` option is enabled, ensure that the `PERS > RES` option is set to `3Ch`. This will ensure that the master intensity channel occurs immediately after the red, green and blue control channels, at channel 4.

Control menu contents

Addr	DMX	001	Sets the base DMX address from which the control channels will begin.	
Info	VER	CPU	1 07	Shows the main processor software revision. No changes are possible within this option.
		DISP	1 00	Shows the display controller software revision. No changes are possible within this option.
PRoG	C 1	EFEC	00	Selects the primary internal chase effect. See <i>Chase effects</i> for descriptions. Select ModE > EF M to show the selected chase.
		XFAd	000	Selects the cross fade speed between the steps of the selected C 1 chase effect.
		SPEd	000	Selects the speed of the selected C 1 chase effect.
		LEVl	255	Selects the master intensity level of chase effects C 1 and C2.
	C 2	EFEC	00	Selects the secondary internal chase effect. See <i>Chase effects</i> for descriptions. Select ModE > EF M to show the selected chase.
		XFAd	000	Selects the cross fade speed between the steps of the selected C2 chase effect.
		SPEd	000	Selects the speed of the selected C2 chase effect.
MAN	REd	255	Sets the red intensity. Select ModE > MANU (manual) to show the result.	
	GRN	255	Sets the green intensity. Select ModE > MANU (manual) to show the result.	
	BLUE	255	Sets the blue intensity. Select ModE > MANU (manual) to show the result.	
PERS	RES	54Ch	Legacy option, which should be set to 3Ch for best results when using dmx mode. Thus, if MINT is set on, the master intensity channel will occur at channel 4.	
	DATA	SLAV	Determines whether this fixture will act as a master controlling others. When controlled via DMX this fixture must be set to SLAV .	
	MINT	oFF	dmx and E:B 1 modes only. When set oN this enables the master intensity channel (ch55 for E:B 1 , variable for dmx). This option must be set oN for E:B 1 mode.	
	RSET	NA	Legacy option that is no longer available.	
	dINT	15	Determines the intensity of the four digit control panel display and blue status indicators. Values range from 0 (dimkest) to 15 (brightest).	
	DISP	oN	When set to oFF , the control panel display will blank out 60 seconds after the menu is exited. The blue status indicators will remain active.	
				RGB control using variable DMX channels determined by PERS > RES setting. MINT set to oN provides a master intensity. No chase effects are selectable.
Mode	DMX		Displays the resulting RGB levels that are set via the MAN section of the internal menu. External DMX control is not possible in this mode.	
	MANU		Ch1 to 3: C 1 Effect, Speed & Xfade, Ch4 to 6: C2 Effect, Speed & Xfade, Ch7: Master intensity, Ch8-10: RGB.	
	EF d		Displays the chase effect(s) determined within the PRoG section. External DMX control is not possible in this mode.	
	EF M		Legacy mode which makes inefficient use of DMX channels. Use MA:2 in preference.	
	E×B 1		Legacy mode which makes inefficient use of DMX channels. Use MA:2 in preference.	
	MA× 1		DMX Ch1 to 3: RGB, Ch4 to 6: C 1 Effect, Speed & Xfade, Ch7 to 9: C2 Effect, Speed & Xfade, Ch10: Master intensity.	
	MA×2			

Using master mode to drive other units

This unit can control any number of other Pixel Range fixtures via DMX links, without the need for a control desk.

- 1 Set this unit as **master** (*PERFS > dATA > MAST*) and ensure all others are set to **slave** (*PERFS > dATA > SLAVE*). Connect all fixtures via DMX daisy-chain.
- 2 Set each slave to *ModE > dM*.
- 3 Set each slave DMX address (using *AddrP > dM*) according to the following:

18 cells are output in groups of 3 DMX channels to give RGB values per cell (54 channels in total). Set the address of each slave fixture according to which of the 18 cells you want them to appear within, or to begin with (for multi-cell fixtures): *RGB 1* for cell 1, *RGB 4* for cell 2, ... *RGB 2* for cell 18). Set RGBA slave fixtures to 3 channel mode (using *PERFS > RES > 3Ch*).

- 4 Set the master to *ModE > EF M* (the master unit's DMX address is ignored). On the master, choose the required effects to display and send to the slave fixtures using *PRPG > C 1* and *C 2*.

Troubleshooting

Fixture remains at blackout when illumination expected

- The **power** indicator should be lit - if not, check the input power and fuse (see below).
- If live DMX is connected, the **data** indicator should be lit - if not, check the DMX cable and the desk output.
- Check that the selected *ModE* matches the desk personality being used.
- The master intensity channel for the current mode may be set at zero. For *EF 1* and *dM* modes, check the setting of *PERFS > MINT*. For *EF 1* mode, *MINT* must be set *off*.
- Ensure that only one DMX device in the chain is set as master.
- Standalone chase effects: Effects programmed using *PRPG > C 1* and *C 2* but the fixture is not in *ModE > EF M* mode. Check also that *PRPG > LEVL* is not set at zero.
- Standalone RGB mixing: Colour values set within *MANU* section but the fixture is not in *ModE > MANU* mode.

Fuse access

The single fuse is located at the rear of the fixture near to the DMX input connector. Use a small flat blade screw driver to twist the fuse holder anticlockwise until the carrier can be extracted to reveal the fuse.

Fuse type: 20mm 2A (T2AH)
anti-surge, ceramic body

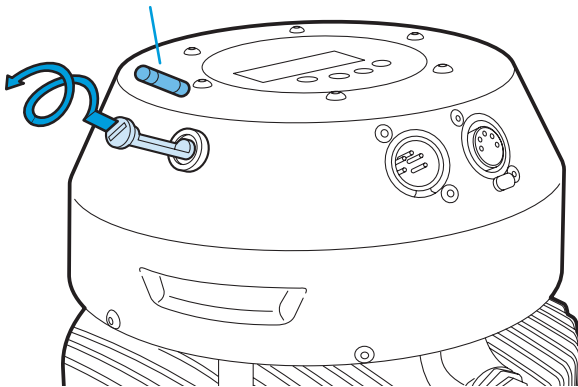

Documentation by **Corporate Text & Design** (www.ctxd.com)
Release 1.1g

Specifications

Dimensions

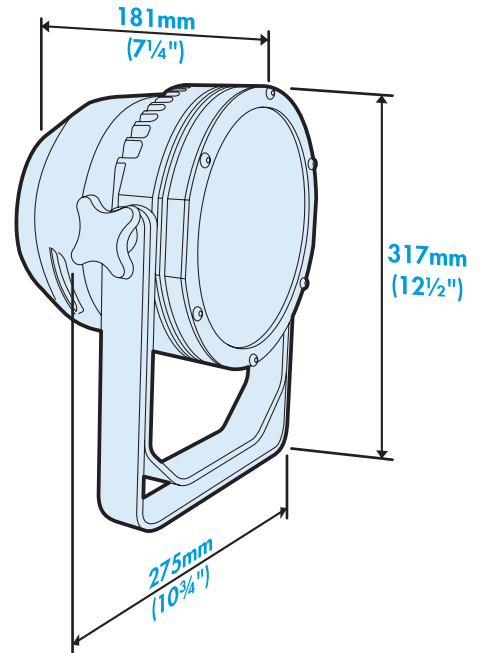

Weight

Fixture and yoke: 6.8kg (15 lbs)

Power

Input voltage:	90 to 264V AC, 47 to 63Hz autosensing	
Earth leakage	0.39mA	
Connectors:	Supplied with cable only: live, neutral & earth	
Power requirements:	@ 230V/50Hz	@ 115V/60Hz
Standby	10 watts	10 watts
Maximum (const.)	110 watts	110 watts
Start up (peak*)	30 amps	15 amps

* The peak value occurs only at first power up and lasts only for a period measured in microseconds.

Approvals



Miscellaneous

Enclosure rating: IP20 (not protected against moisture ingress)
Control input: USITT DMX512 (input connector pin out below)

